

FR Annexe

ES Apéndice

PT Anexo

IT Appendice

EL Παράρτημα

PL Załącznik

RU Приложение

UK Додаток

RO Anexa

EN Appendix

3276005990456	** QUAD212-W3-C	(980-1220)x1900 white	* DOP207758/0001/2015
3276005719286	** QUAD212-W3	(980-1220)x1900 white	* DOP207758/0001/2015
3276005990494	** QUAD212-S3-C	(980-1220)x1900 silver	* DOP207758/0001/2015
3276005620629	** QUAD212-S3	(980-1220)x1900 silver	* DOP207758/0001/2015



QUAD

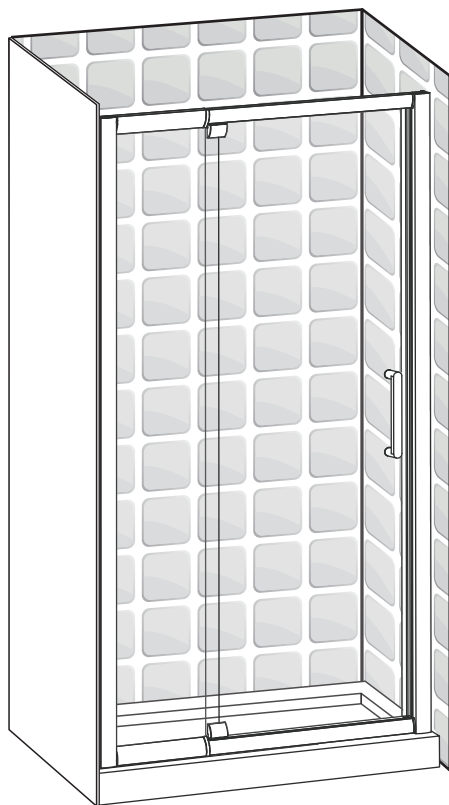

- FR** Notice de Montage, Utilisation, Entretien
- ES** Instrucciones de Montaje, Utilización y Mantenimiento
- PT** Instruções de Montagem, Utilização e Manutenção
- IT** Istruzioni per il Montaggio, l'Uso e la Manutenzione
- EL** Εγχειρίδιο συναρμολόγησης, χρήσης και συντήρησης
- PL** Instrukcja Montażu, Użytkowania i Konserwacji
- RU** Руководство По Сборке и Эксплуатации
- UK** Керівництво По Збірці і Експлуатації
- RO** Manual asamblare, utilizare și întreținere
- EN** Assembly - Use - Maintenance Manual



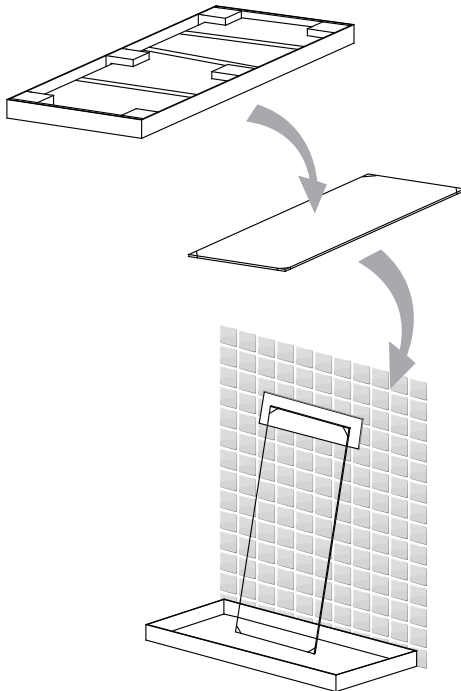
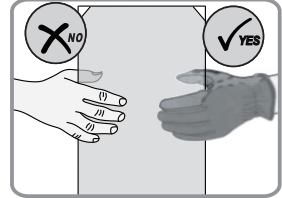
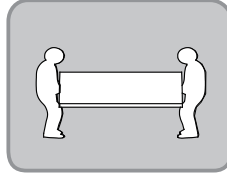
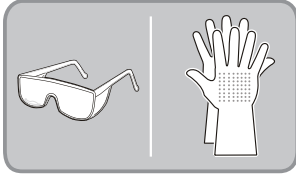
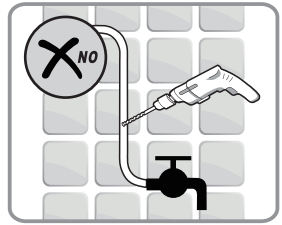
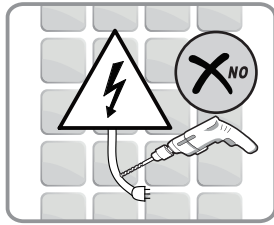
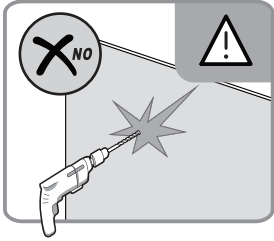

FR Vérifiez que les chevilles murales fournies sont appropriées à votre mur (celles fournies dans l'emballage sont conçues pour le béton). Sinon, utilisez des vis et des chevilles murales adaptées au type de matériau de votre mur. Pour obtenir des conseils concernant les vis et les chevilles appropriées à votre mur, demandez à un vendeur spécialisé.

ES Compruebe que todos los tacos suministrados puedan ser utilizados con su pared (los incluidos en la caja son para hormigón). En caso contrario, utilice tornillos y tacos de pared apropiados para el material de su pared. Para información acerca de las fijaciones y tornillos apropiados para su pared, consulte con un asistente de ventas especializado.

PT Certifique-se de que as buchas fornecidas são adequadas à sua parede (as fornecidas na embalagem são para betão). Caso contrário, use parafusos e buchas adequados ao tipo de material da sua parede. Para se aconselhar acerca dos parafusos e buchas adequados à sua parede, fale com um assistente de vendas especializado.

IT Verificare che i tasselli da parete forniti siano compatibili con la propria parete (quelli forniti con l'articolo sono per cemento). Altrimenti, utilizzare viti e tasselli adatti per la superficie della propria parete. Per ottenere consigli e suggerimenti sulle viti e i tasselli più adatti alla propria parete, consultare un rivenditore specializzato.

EL Βεβαιωθείτε ότι οι παρεχόμενες στερεώσεις τοίχου είναι κατάλληλες για τον τοίχο σας (οι παρεχόμενες στη συσκευή προορίζονται για μπετό). Αλλιώς χρησιμοποιήστε βίδες και στερεώσεις τοίχου κατάλληλες για τον τύπο υλικού του τοίχου σας. Για να λάβετε συμβουλές σχετικά με τις κατάλληλες βίδες και τα εξαρτήματα για τον τοίχο σας, ρωτήστε έναν ειδικό πωλητή.

PL Prosimy sprawdzić, czy dostarczone kołki do ścian nadają się do użycia w posiadanej ścianie (kołki dostarczone w zestawie są przeznaczone do betonu). Jeśli tak nie jest, należy użyć śrub i kołków odpowiednich do materiału, z którego wykonana jest ściana. Aby uzyskać poradę w sprawie śrub i elementów montażowych odpowiednich do danego typu ściany, należy zwrócić się z pytaniem do wyspecjalizowanego sprzedawcy.

RU Убедитесь, что прилагаемые дюбеля подходят для ваших стен (входящие в комплект дюбеля предназначены для бетона). В противном случае используйте шурупы и дюбеля, соответствующие материалу стены. Для получения рекомендаций по выбору шурупов и крепежных деталей, подходящих для вашей стены, обратитесь к специалисту-консультанту.

UK Перевірте, що анкери підходять для вашої стіни (ті, що постачаються в упаковці – для бетону). В іншому випадку використовуйте гвинти й стінові анкери, що відповідають матеріалу вашої стіни. Для отримання консультацій щодо гвинтів й фітінгів для вашої стіни зверніться до відповідного продавця-консультанта.

RO Verificați ca toate ancorele de perete furnizate să fie adecvate pentru peretele dumneavoastră (cele furnizate în pachet sunt pentru beton). În caz contrar, folosiți șuruburi și ancore de perete adecvate pentru tipul de material din care este peretele dumneavoastră. Pentru a obține recomandări privind șuruburile și armăturile adecvate pentru peretele dumneavoastră, întrebați un vânzător specializat.

EN Check that wall anchors provided are suitable for your wall (those provided in the package are for concrete). Otherwise, use screws and wall anchors suited to the type of material of your wall. To obtain advice on the screws and fittings suited to your wall, ask a specialized sales assistant.



Assemble with this side, with easy clean treatment, on the inside.

İze karşı işleme tabi tutulmuş bu yüz iç tarafa doğru konulmalıdır

Cette face, avec un traitement facilement nettoyyable, doit être positionnée vers l'intérieur

Esta cara está tratada para facilitar su limpieza y se debe colocar hacia el interior

Esta face com tratamento para facilitar a limpeza, deve ficar voltada para o interior

Questo lato, deve essere posizionato con il trattamento easy clean all'interno.

Эта сторона, обработанная средством против образования накипи, должна быть обращена вовнутрь.

Сторона, оброблена засобом проти накипу, повинна бути звернена всередину.

Această față, tratată pentru curățare ușoară, trebuie poziționată spre interior

Strona z powłoką zapewniającą łatwe czyszczenie powinna być skierowana do wewnątrz.

Αυτή η όψη, με επεξεργασία για εύκολο καθαρισμό, πρέπει να τοποθετηθεί προς το εσωτερικό.



Attention danger / Atención: Peligro / Atenção perigo / Attenzione pericolo / Προσοχή κίνδυνος /
Uwaga niebezpieczeństwo / Внимание! Опасно! / Увага! Небезпечно! / Ateňtie, pericol / Caution danger



Correct / Correcto / Correcto / Corretto / Σωστό / Dobrze / Правильный /
Правильно / Corect / Correct



Incorrect / Incorrecto / Incorrecto / Errato / Λάθος / Źle / Неправильный /
Неправильно / Incorect / Incorrect

Notes / Observaciones / Notas / Note / Σημειώσεις / Notatki / Примечания / Примітки / Note / Notes

A

FR Préparation

ES Preparación

PT Preparação

IT Preparazione

EL Προετοιμασία

PL Przygotowanie

RU Подготовка

UK Підготування

RO Pregătire

EN Preparation

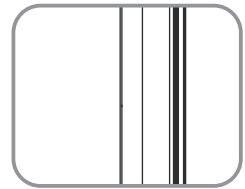
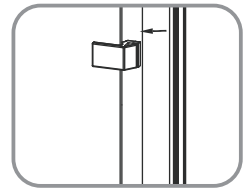
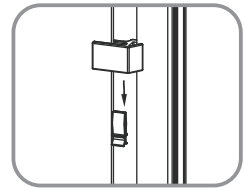
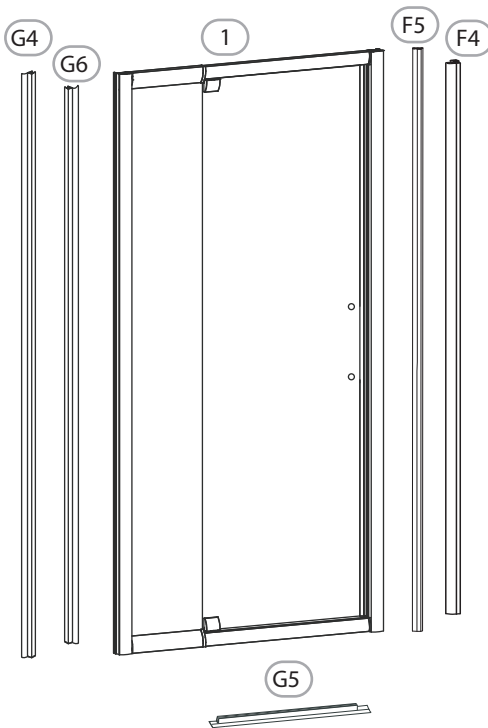
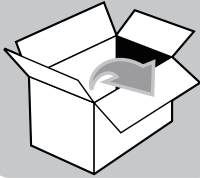

FR Préparation

ES Preparación

PT Preparação

IT Preparazione

EL Προετοιμασία

PL Przygotowanie

RU Подготовка

UK Підготування

RO Pregătire

EN Preparation

A

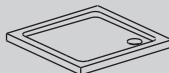
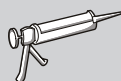
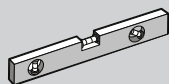
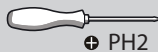
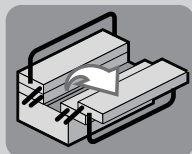
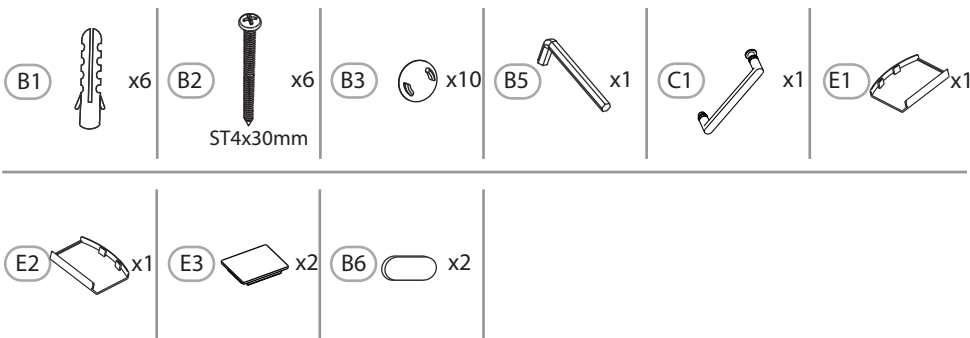
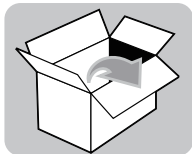

B

FR Montage

ES Montaje

PT Montagem

IT Montaggio

EL Συναρμολόγηση

PL Montaż

RU Сборка

UK Збірка

RO Montaj

EN Assembly

1

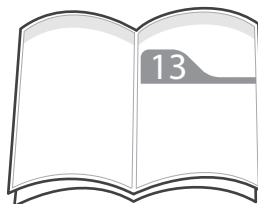
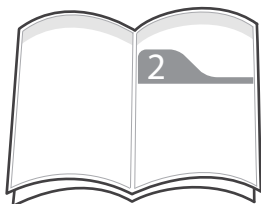
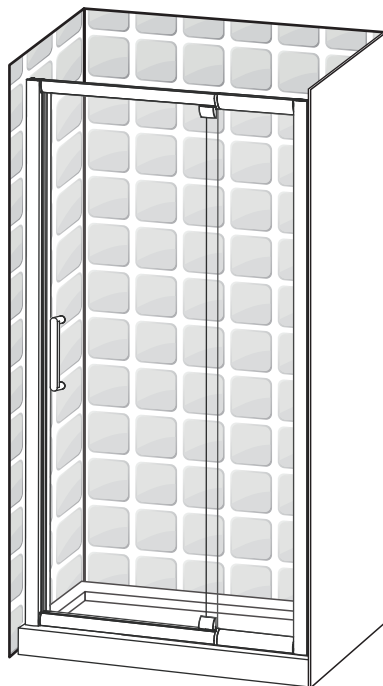
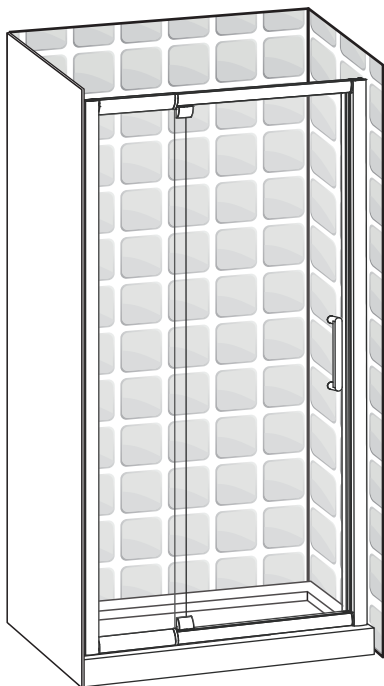

FR Montage

ES Montaje

PT Montagem

IT Montaggio

EL Συναρμολόγηση

PL Montaż

RU Сборка

UK Збірка

RO Montaj

EN Assembly

B

2

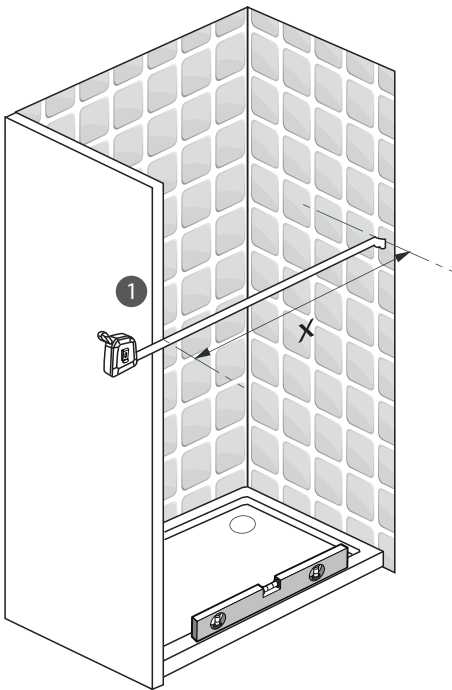

QUAD	X(mm)
(980-1220)X1900mm	980--1220

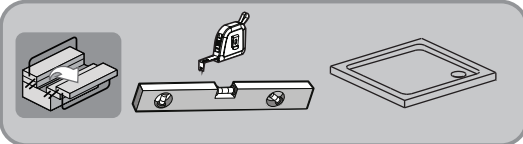
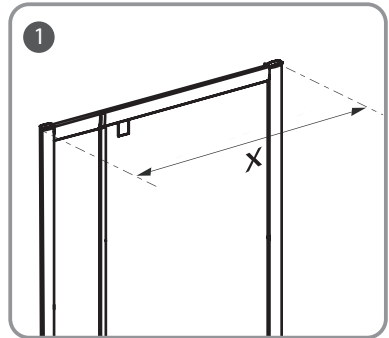

B

FR Montage

ES Montaje

PT Montagem

IT Montaggio

EL Συναρμολόγηση

PL Montaż

RU Сборка

UK Збірка

RO Montaj

EN Assembly

3

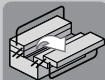
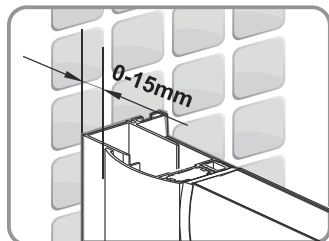
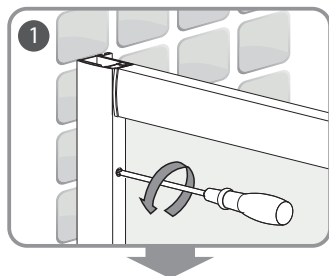
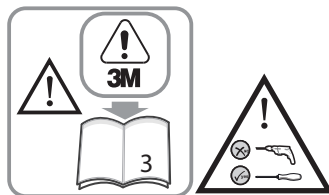
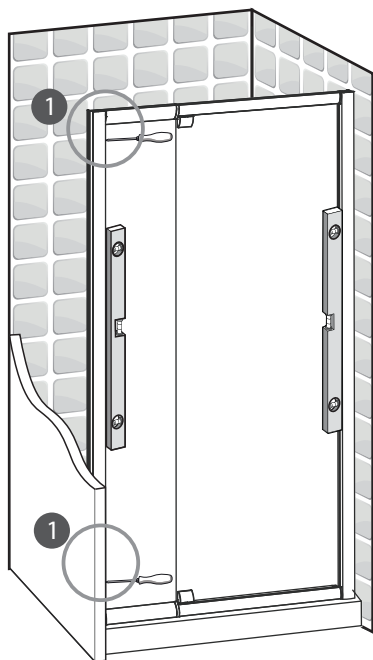

1



x1



FR Montage

ES Montaje

PT Montagem

IT Montaggio

EL Συναρμολόγηση

PL Montaż

RU Сборка

UK Збірка

RO Montaj

EN Assembly

B

4

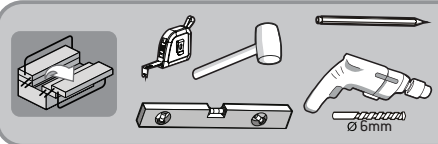
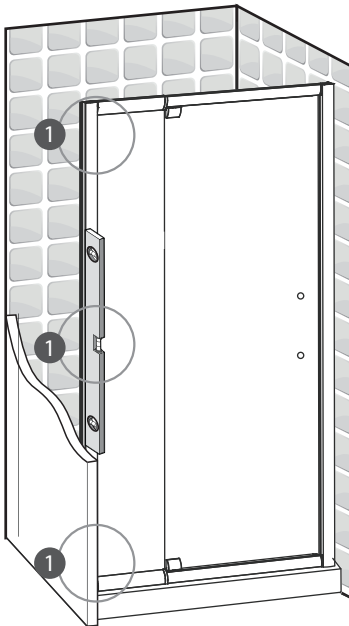
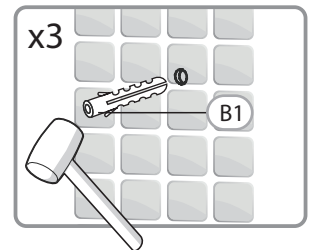
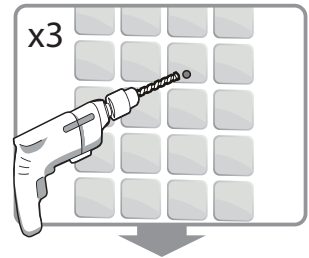
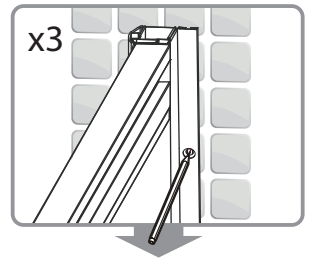
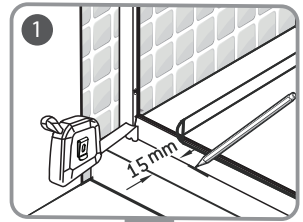
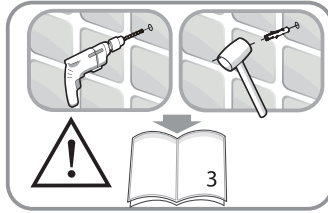

B1



x3



B

FR Montage

ES Montaje

PT Montagem

IT Montaggio

EL Συναρμολόγηση

PL Montaż

RU Сборка

UK Збірка

RO Montaj

EN Assembly

5

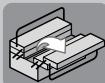
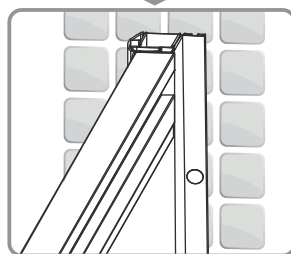
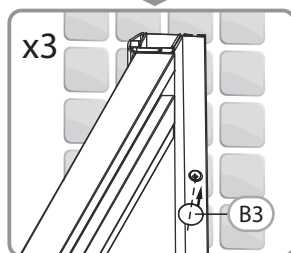
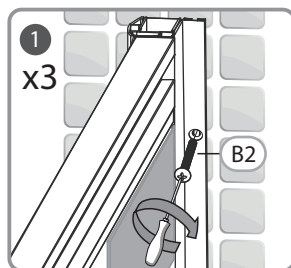
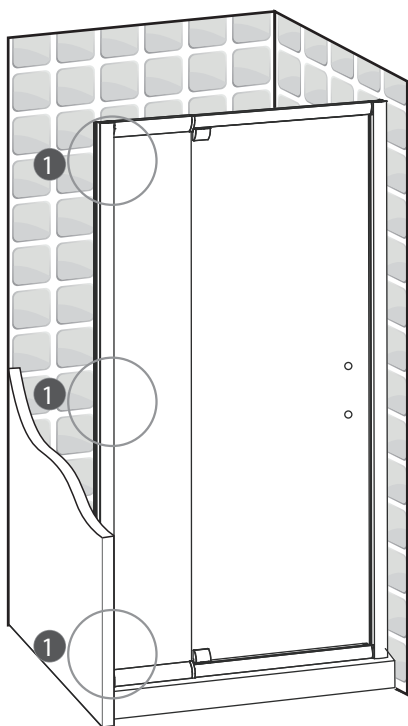

PH2

B2



x3

ST4x30mm

B3



x3



FR Montage

ES Montaje

PT Montagem

IT Montaggio

EL Συναρμολόγηση

PL Montaż

RU Сборка

UK Збірка

RO Montaj

EN Assembly

B

6

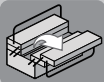
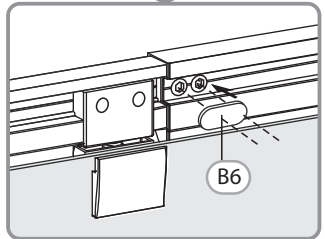
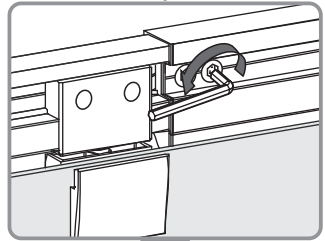
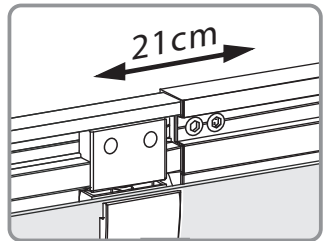
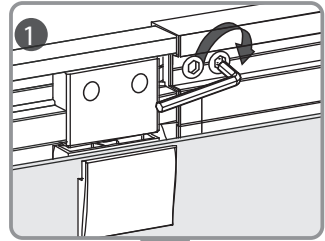
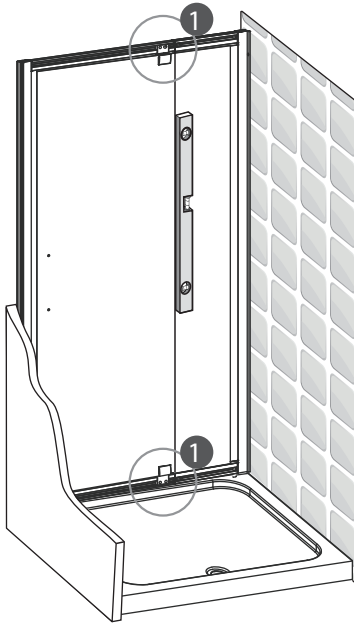

B5



x1

B6



x2



B

FR Montage

ES Montaje

PT Montagem

IT Montaggio

EL Συναρμολόγηση

PL Montaż

RU Сборка

UK Збірка

RO Montaj

EN Assembly

7

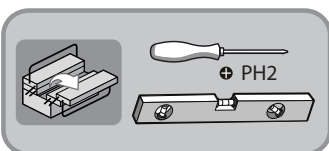
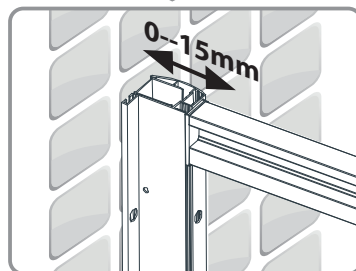
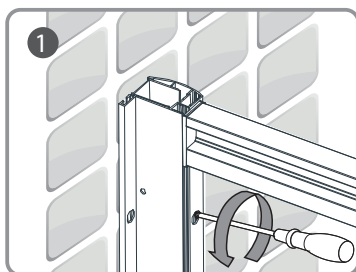
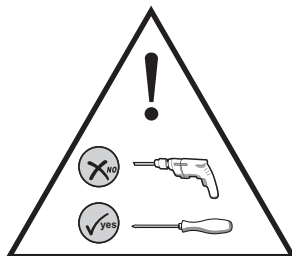
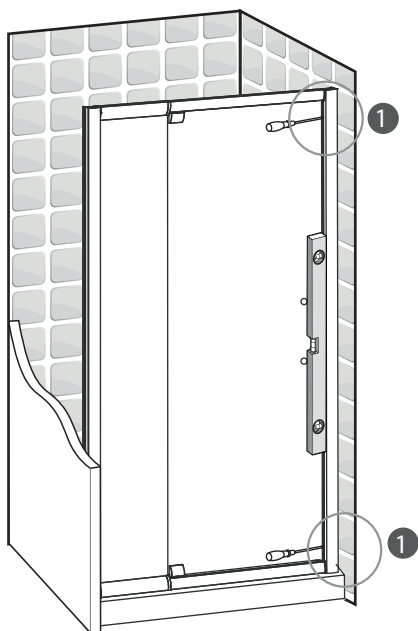

FR Montage

ES Montaje

PT Montagem

IT Montaggio

EL Συναρμολόγηση

PL Montaż

RU Сборка

UK Збірка

RO Montaj

EN Assembly

B

8

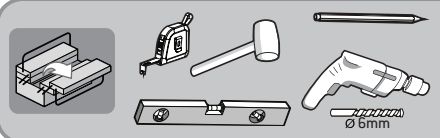
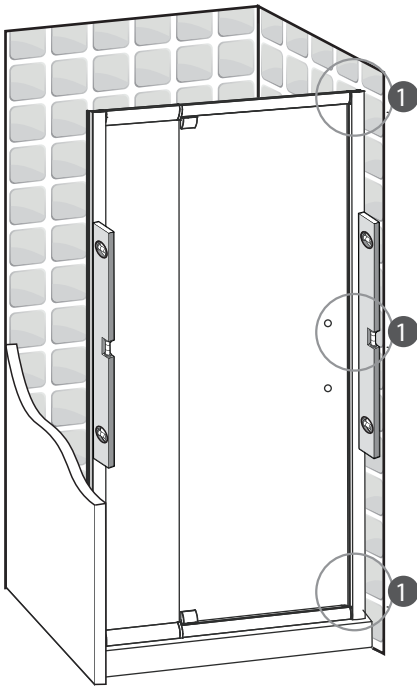
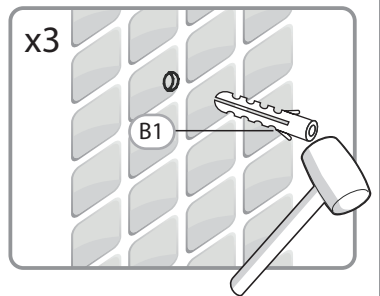
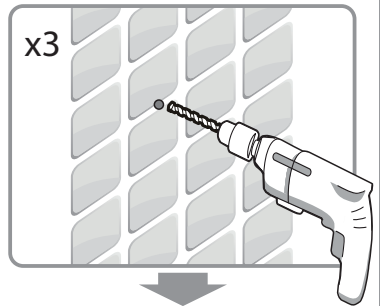
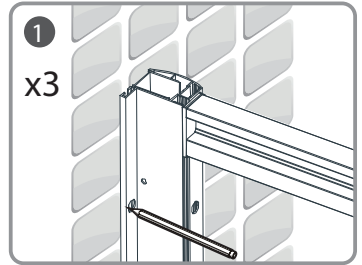
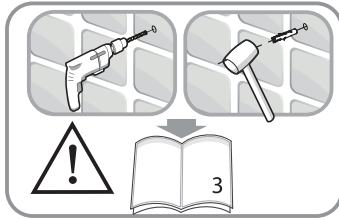

B1



x3



B

FR Montage

ES Montaje

PT Montagem

IT Montaggio

EL Συναρμολόγηση

PL Montaż

RU Сборка

UK Збірка

RO Montaj

EN Assembly

9

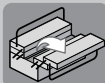
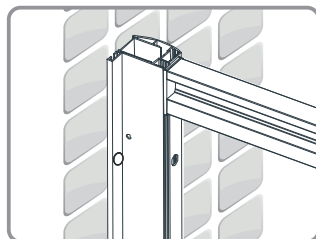
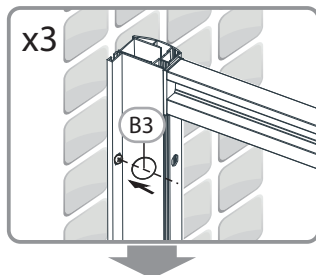
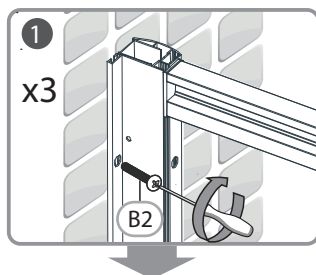
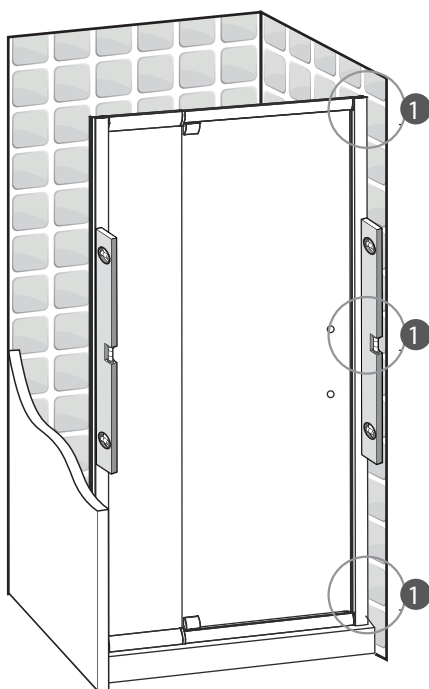

PH2

B2



x3

ST4x30mm

B3



x3



FR Montage

ES Montaje

PT Montagem

IT Montaggio

EL Συναρμολόγηση

PL Montaż

RU Сборка

UK Збірка

RO Montaj

EN Assembly

B

10

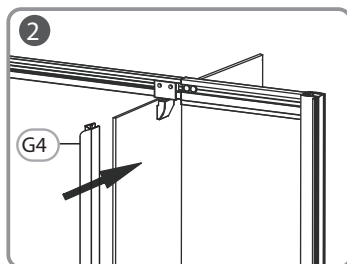
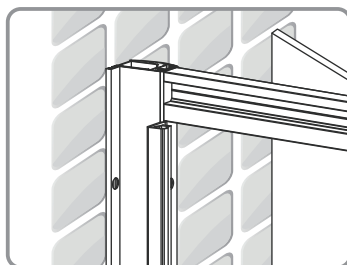
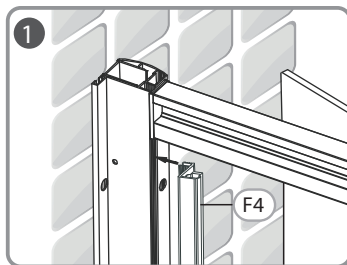
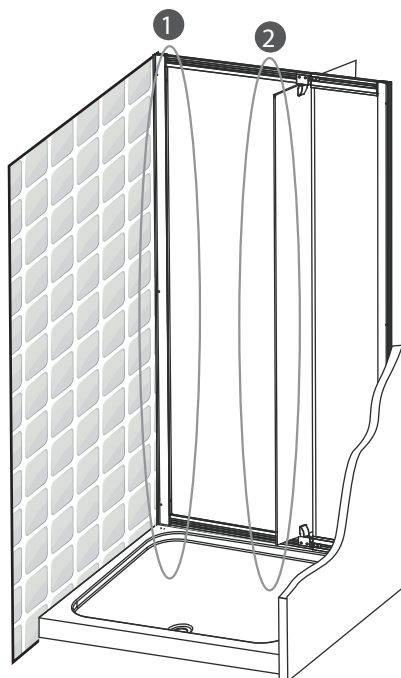

F4



x1

G4



x1



B

FR Montage

ES Montaje

PT Montagem

IT Montaggio

EL Συναρμολόγηση

PL Montaż

RU Сборка

UK Збірка

RO Montaj

EN Assembly

11

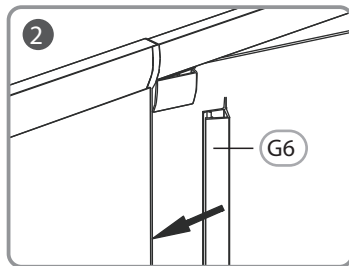
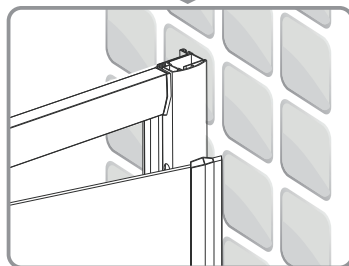
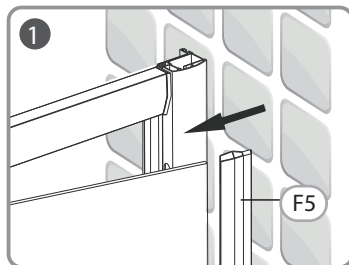
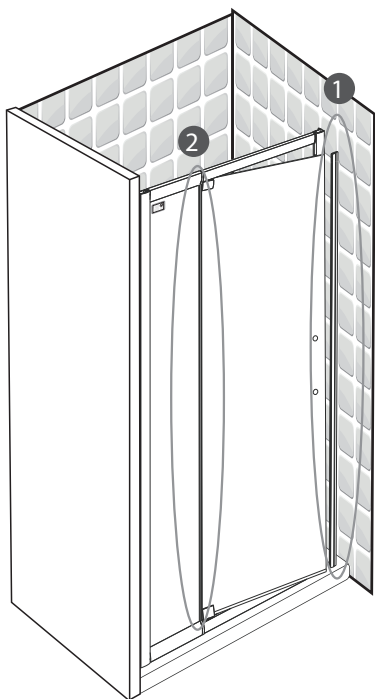

F5



x1

G6



x1



FR Montage

ES Montaje

PT Montagem

IT Montaggio

EL Συναρμολόγηση

PL Montaż

RU Сборка

UK Збірка

RO Montaj

EN Assembly

B

12

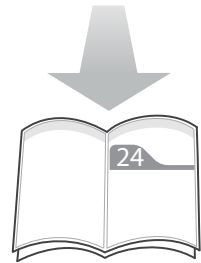
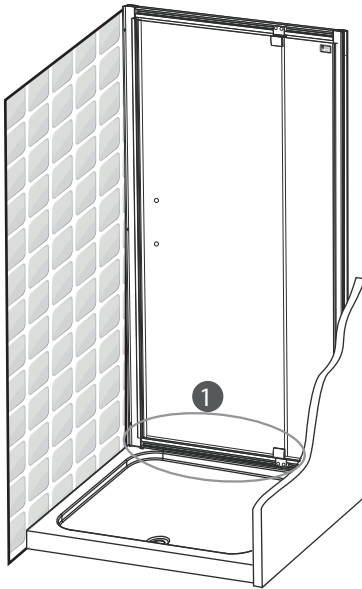
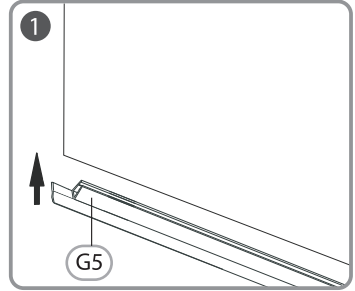
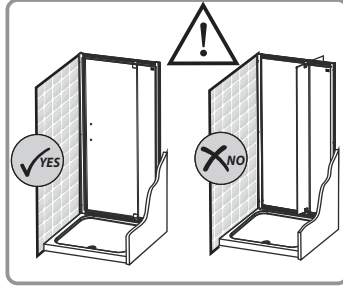

G5



x1



B

FR Montage

ES Montaje

PT Montagem

IT Montaggio

EL Συναρμολόγηση

PL Montaż

RU Сборка

UK Збірка

RO Montaj

EN Assembly

13

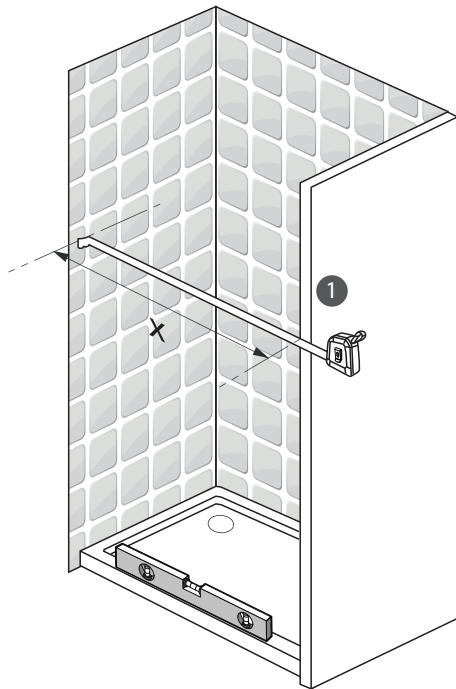

QUAD	X(mm)
(980-1220)X1900mm	980--1220

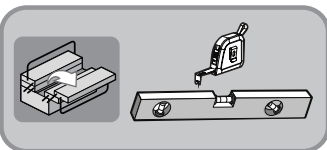
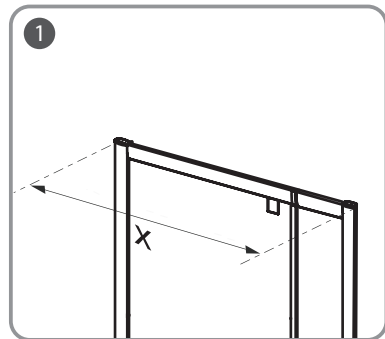

FR Montage

ES Montaje

PT Montagem

IT Montaggio

EL Συναρμολόγηση

PL Montaż

RU Сборка

UK Збірка

RO Montaj

EN Assembly

B

14

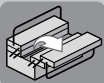
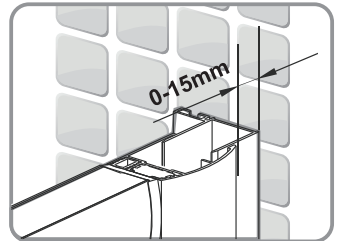
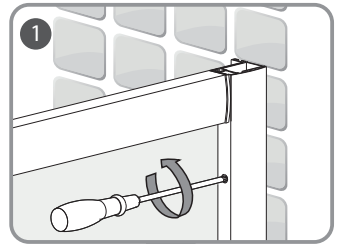
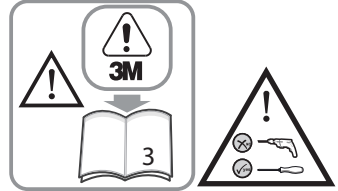
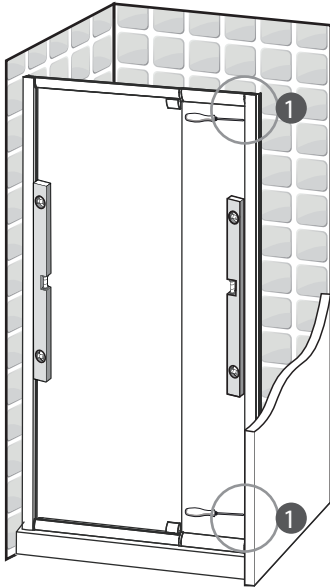

1

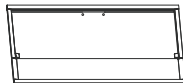

x1



B

FR Montage

ES Montaje

PT Montagem

IT Montaggio

EL Συναρμολόγηση

PL Montaż

RU Сборка

UK Збірка

RO Montaj

EN Assembly

15

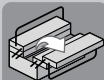
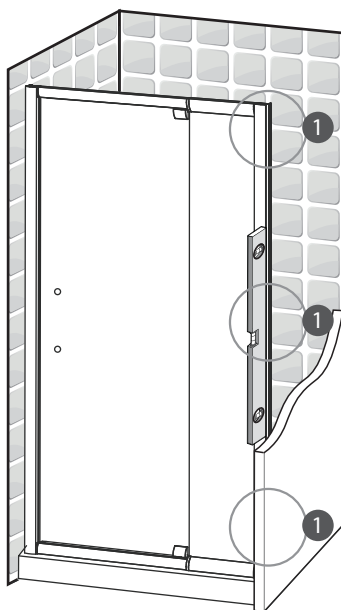
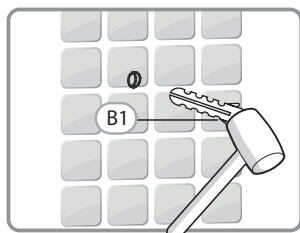
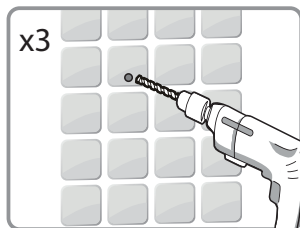
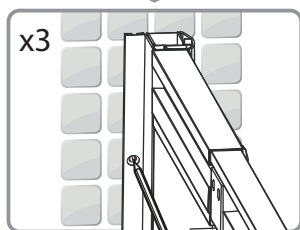
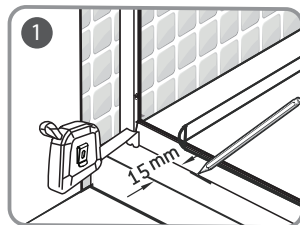
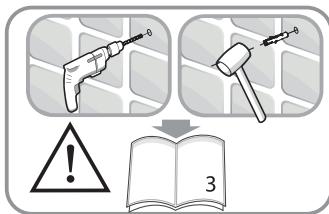

B1



x3



FR Montage

ES Montaje

PT Montagem

IT Montaggio

EL Συναρμολόγηση

PL Montaż

RU Сборка

UK Збірка

RO Montaj

EN Assembly

B

16

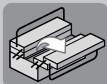
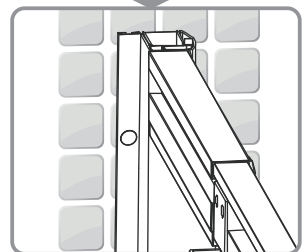
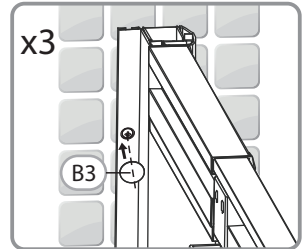
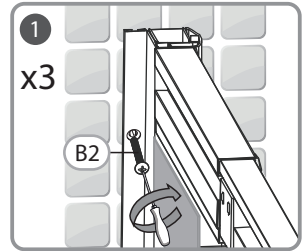
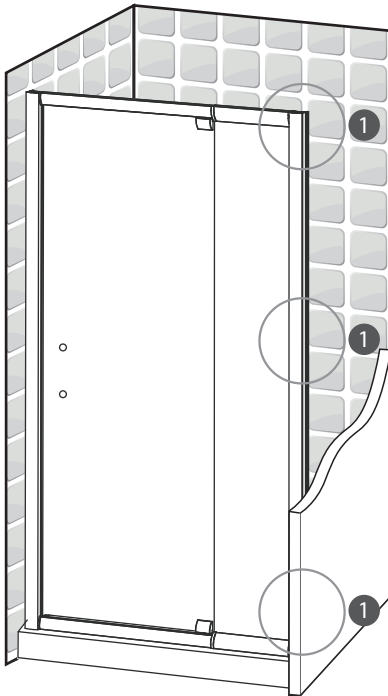

PH2

B2



x3

ST4x30mm

B3



x3



B

FR Montage

ES Montaje

PT Montagem

IT Montaggio

EL Συναρμολόγηση

PL Montaż

RU Сборка

UK Збірка

RO Montaj

EN Assembly

17

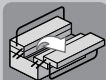
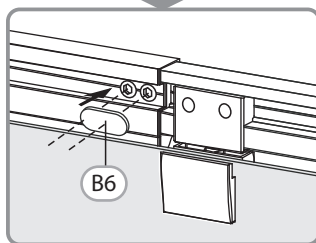
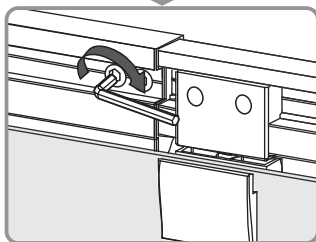
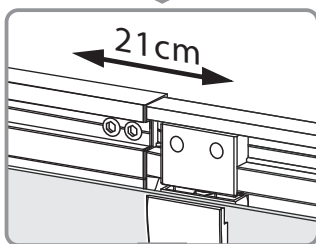
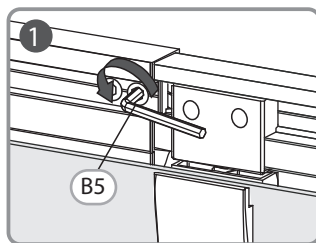
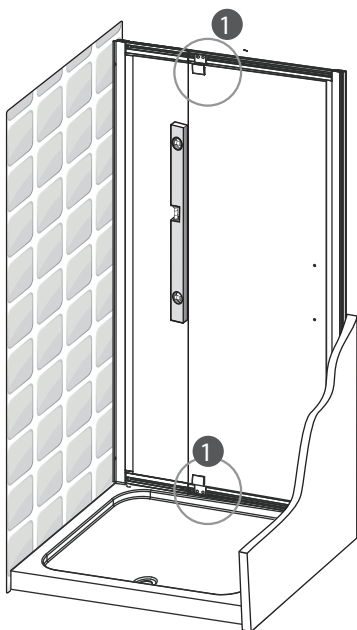

B5



x1

B6



x2



FR Montage

ES Montaje

PT Montagem

IT Montaggio

EL Συναρμολόγηση

PL Montaż

RU Сборка

UK Збірка

RO Montaj

EN Assembly

B

18

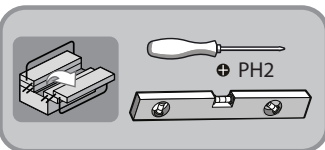
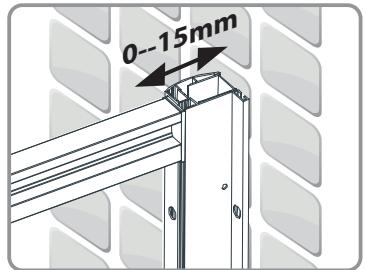
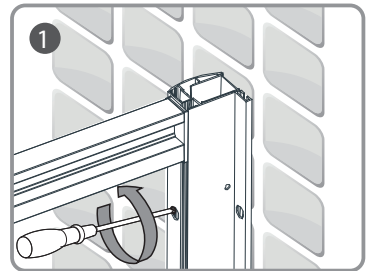
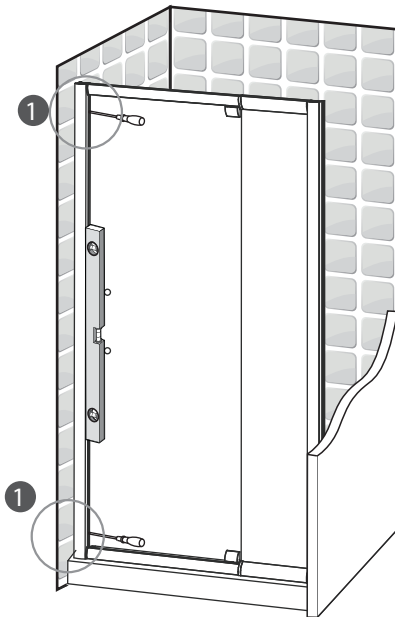

B

FR Montage

ES Montaje

PT Montagem

IT Montaggio

EL Συναρμολόγηση

PL Montaż

RU Сборка

UK Збірка

RO Montaj

EN Assembly

19

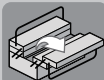
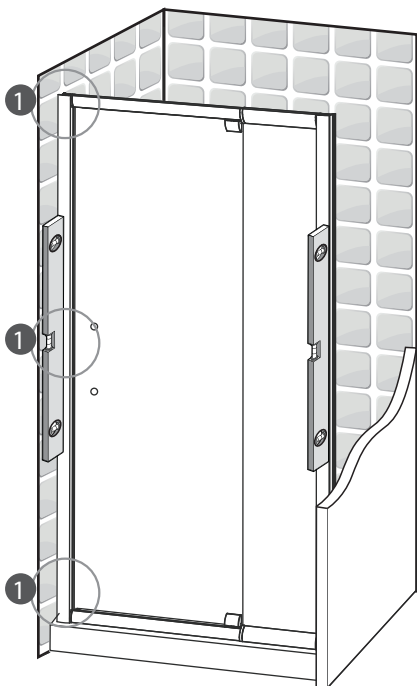
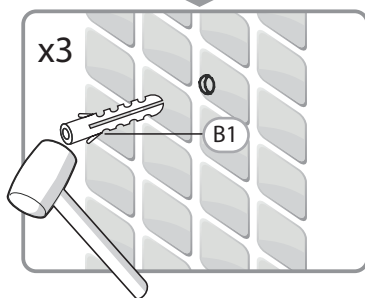
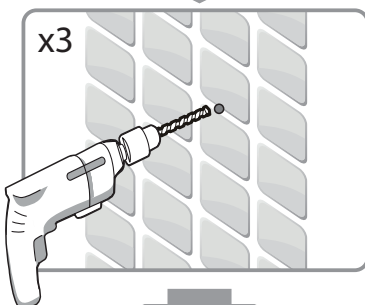
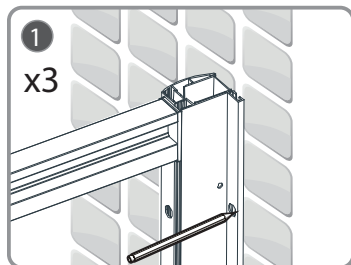
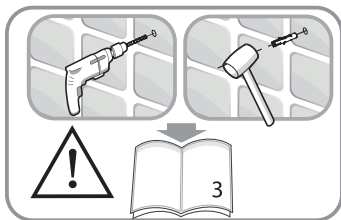

B1



x3



FR Montage

ES Montaje

PT Montagem

IT Montaggio

EL Συναρμολόγηση

PL Montaż

RU Сборка

UK Збірка

RO Montaj

EN Assembly

B

20

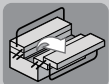
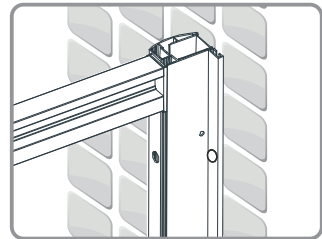
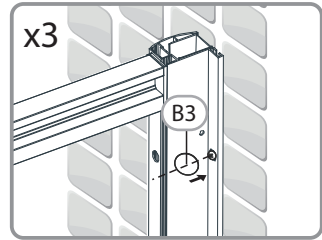
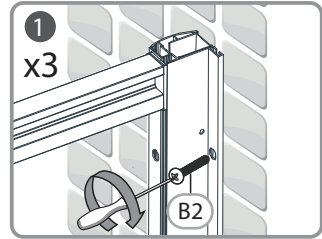
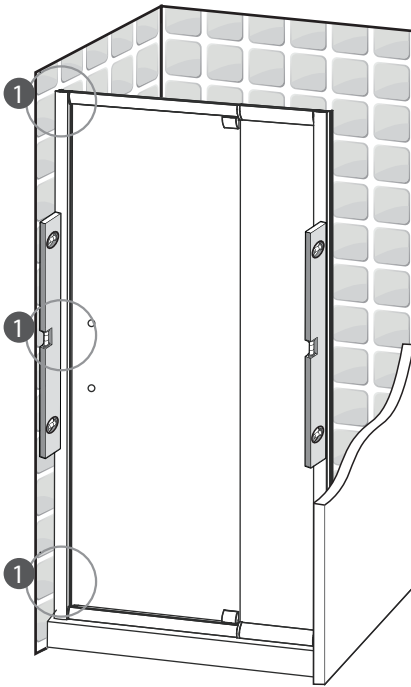

PH2

B2



x3

ST4x30mm

B3



x3



B

FR Montage

ES Montaje

PT Montagem

IT Montaggio

EL Συναρμολόγηση

PL Montaż

RU Сборка

UK Збірка

RO Montaj

EN Assembly

21

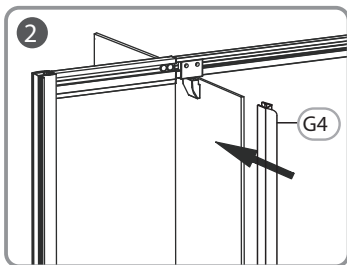
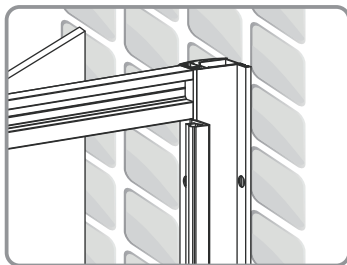
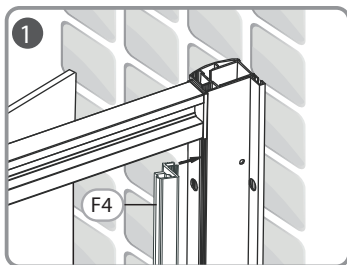
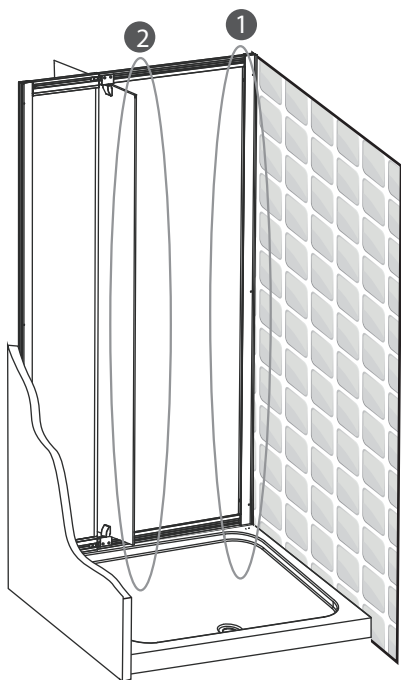

F4



x1

G4



x1



FR Montage

ES Montaje

PT Montagem

IT Montaggio

EL Συναρμολόγηση

PL Montaż

RU Сборка

UK Збірка

RO Montaj

EN Assembly

B

22

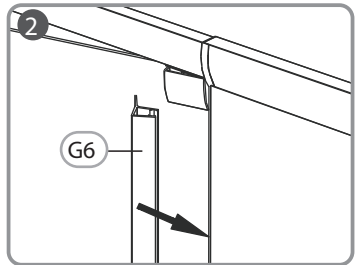
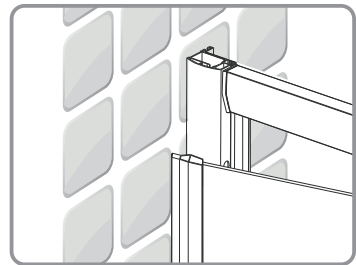
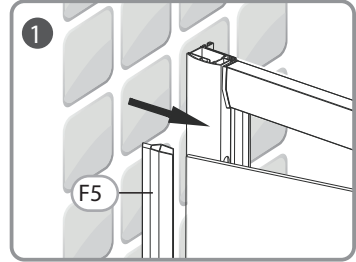
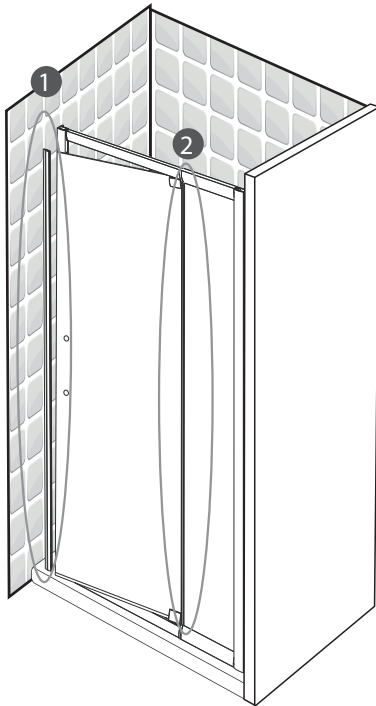

F5



x1

G6



x1



B

FR Montage

ES Montaje

PT Montagem

IT Montaggio

EL Συναρμολόγηση

PL Montaż

RU Сборка

UK Збірка

RO Montaj

EN Assembly

23

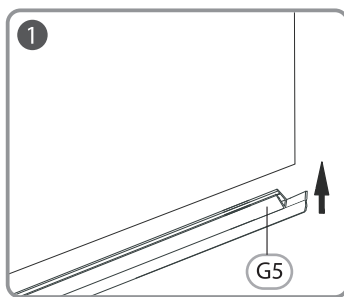
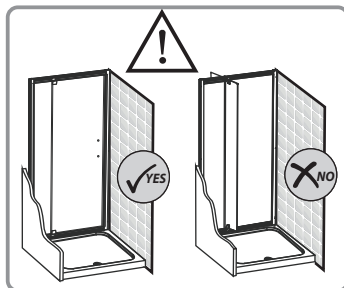
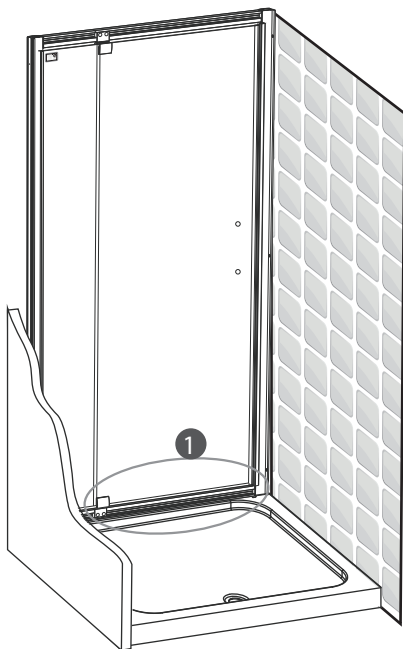

G5



x1



FR Montage

ES Montaje

PT Montagem

IT Montaggio

EL Συναρμολόγηση

PL Montaż

RU Сборка

UK Збірка

RO Montaj

EN Assembly

B

24

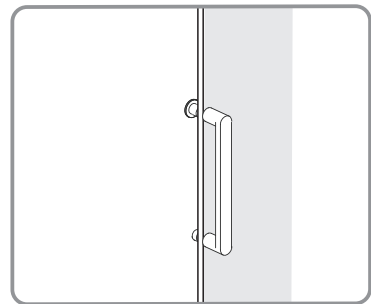
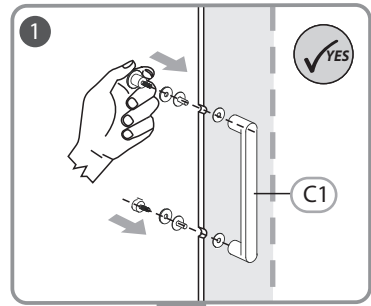
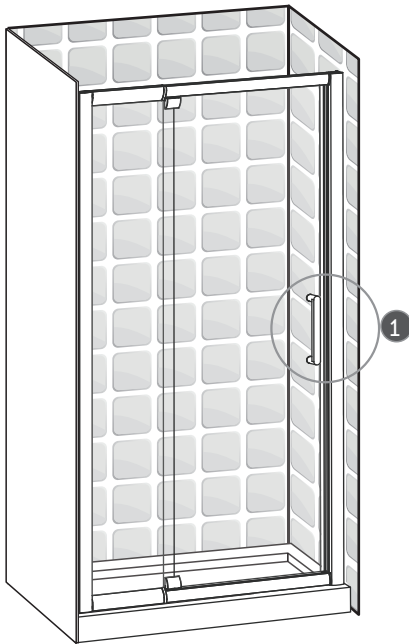

C1



x1



B

FR Montage

ES Montaje

PT Montagem

IT Montaggio

EL Συναρμολόγηση

PL Montaż

RU Сборка

UK Збірка

RO Montaj

EN Assembly

25

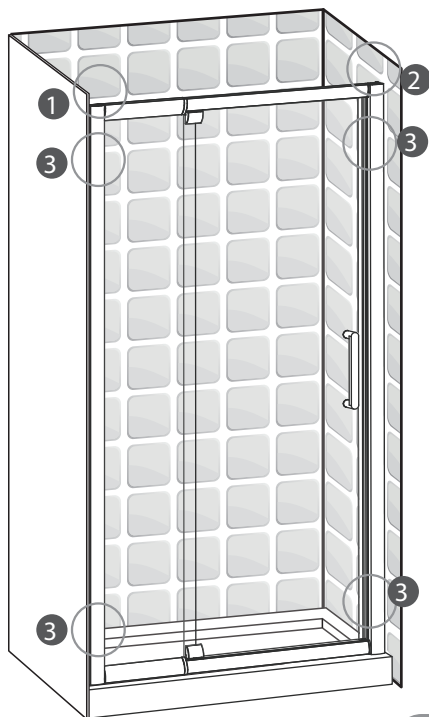
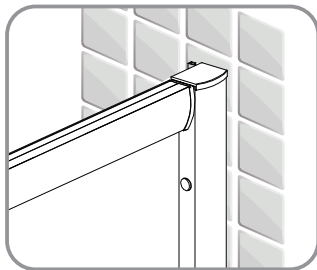
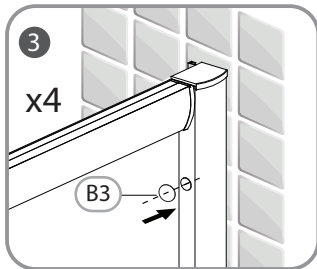
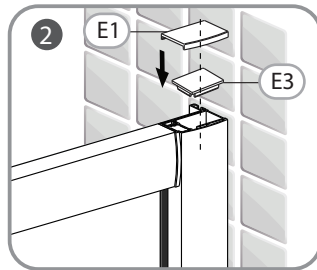
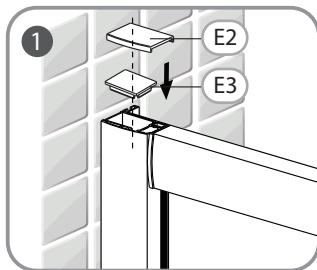

E1



x1

E2



x1

E3



x2

B3



x4



FR Montage

ES Montaje

PT Montagem

IT Montaggio

EL Συναρμολόγηση

PL Montaż

RU Сборка

UK Збірка

RO Montaj

EN Assembly

B

26

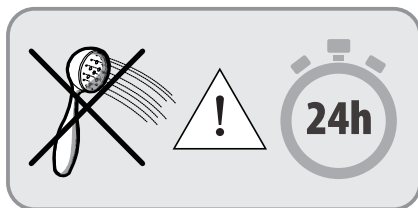
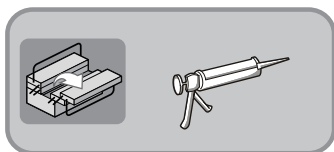
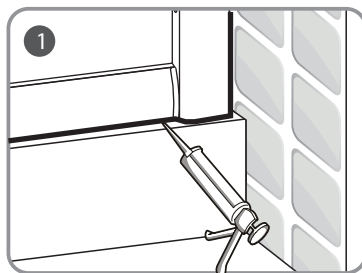
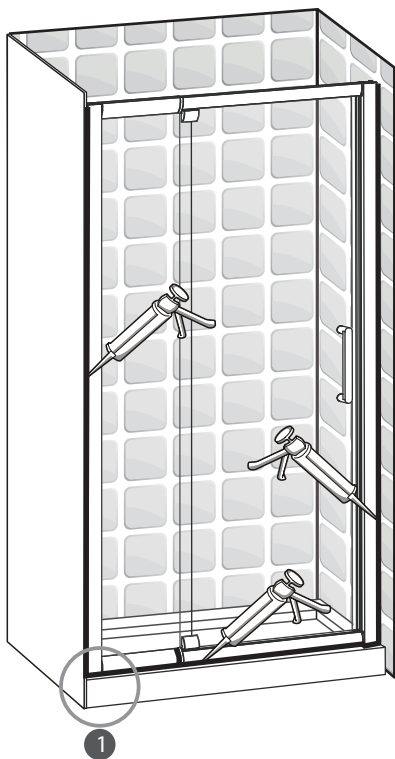

C

FR Entretien

EL Συντήρηση

RO Întreținere

ES Mantenimiento

PL Konserwacja

EN Maintenance

PT Serviço

RU Уход

IT Manutenzione

UK Догляд



Sans solvant / Sin disolvente / Sem solventes / Senza solventi / Χωρίς διαλυτικά / Bez rozpuszczalnika / Без растворителя / Без розчинника / Fără solvent / Solvent-free

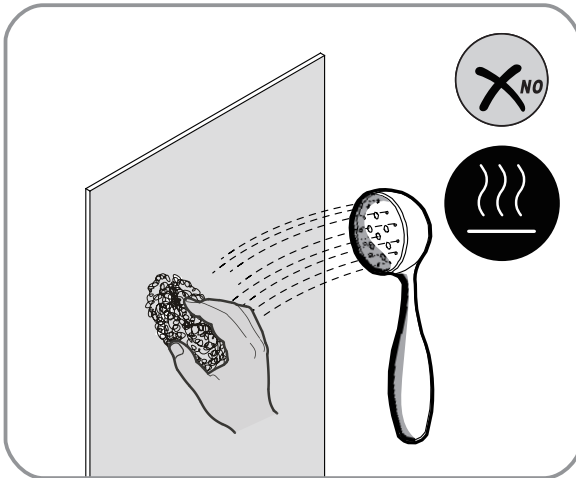
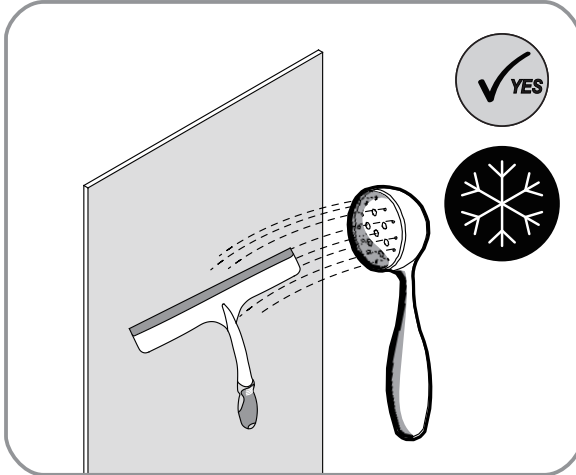

FR



ADEO Services - 135 Rue Sadi Carnot - CS 00001 59790 RONCHIN - France
16
EN 14428:2015

Code d'identification unique du produit type: **
usage prévu: hygiène personnelle
Nettoyable: Conforme
Résistance à l'impact/
Capacité de Fragmentation: Conforme
durabilité: Conforme

DOP N °*

ES



ADEO Services - 135 Rue Sadi Carnot - CS 00001 59790 RONCHIN - France
16
EN 14428:2015

Código de identificación única del producto tipo: **
Uso previsto: higiene personal
Limpiable: Conforme
Resistencia al impacto/
Capacidad de fragmentación: Conforme
Durabilidad: Conforme

DOP N °*

PT



ADEO Services - 135 Rue Sadi Carnot - CS 00001 59790 RONCHIN - France
16
EN 14428:2015

Código de identificação único do produto-tipo: **
Utilização prevista: higiene pessoal
Limpeza: Conforme
Resistência ao impacto/
Capacidade de fragmentação: Conforme
Durabilidade: Conforme

DOP N °*

IT



ADEO Services - 135 Rue Sadi Carnot - CS 00001 59790 RONCHIN - France
16
EN 14428:2015

Codice di identificazione unico del prodotto-tipo: **
Uso previsto: igiene personale
Pulibile: Conforme
Resistenza agli urti/
Capacità di Frammentazione: Conforme
Durata: Conforme

DOP N °*

EL



ADEO Services - 135 Rue Sadi Carnot - CS 00001 59790 RONCHIN - France
16
EN 14428:2015

Μοναδικός κωδικός ταυτοποίησης του τύπου του προϊόντος: **
προβλεπόμενη χρήση: προσωπική υγιεινή
Δυνατότητα καθαρισμού: Σύμφωνα με
Αντοχή σε κρούση/ Ικανότητα κατάτμησης: Σύμφωνα με
Διάρκεια: Σύμφωνα με

DOP N °*

PL



ADEO Services - 135 Rue Sadi Carnot - CS 00001 59790 RONCHIN - France
16
EN 14428:2015

Niepowtarzalny kod identyfikacyjny typu wyrobu: **
przeznaczenie: higiena osobista
Możliwość czyszczenia: Zgodny
Odporność na uderzenia/ Rozkruszalność: Zgodny
Trwałość: Zgodny

DOP N °*

RU



ADEO Services - 135 Rue Sadi Carnot - CS 00001 59790 RONCHIN - France
16
EN 14428:2015

Уникальный идентификационный код типа изделия: **
Назначение: личная гигиена
Легкость очистки: Соответствие
Ударопрочность/ Мощнось распыления: Соответствие
Долговечность: Соответствие

DOP N °*

UK



ADEO Services - 135 Rue Sadi Carnot - CS 00001 59790 RONCHIN - France
16
EN 14428:2015

Унікальний ідентифікаційний код виду продукції: **
призначення: особиста гігієна
Легкість очищення: Відповідність
Ударостійкість/ Потужність розпилення: Відповідність
Довговічність: Відповідність

DOP N °*

RO



ADEO Services - 135 Rue Sadi Carnot - CS 00001 59790 RONCHIN - France
16
EN 14428:2015

Cod unic de identificare a tipului de produs: **
destinație: igienă personală
Posibilitatea de curățare: Conform
Rezistență la impact/ Capacitate de fragmentare: Conform
Durabilitate: Conform

DOP N °*

EN



ADEO Services - 135 Rue Sadi Carnot - CS 00001 59790 RONCHIN - France
16
EN 14428:2015

Unique identification code of the product-type: **
Intended use: personal hygiene
cleanability: Pass
Impact resistance/ shatter properties: Pass
Durability: Pass

DOP N °*

**

FR Reportez-vous à l'annexe.

ES Consulte el apéndice.

PT Consulte o anexo.

IT Consultare l'appendice.

EL Ανατρέξτε στο Παράρτημα.

PL Patrz załącznik.

RU См. приложение.

UK Читайте додаток.

RO Consultați anexa.

EN Refer to appendix.

ADEO Services
135 Rue Sadi Carnot
CS 00001
59790 RONCHIN - France

ТОВ «Леруа Мерлен Україна»,
вул. Полярна 17а, м. Київ
04201, Україна

ООО ЛЕРУА МЕРЛЕН ВОСТОК,
141031, Московская область,
Мытищинский район, г. Мытищи,
Осташковское шоссе, д.1, РОССИЯ

* Garantie 3 ans / Garantía 3 años / Garantia 3 anos / Garanzia 3 anni
Εγγύηση 3 ετών / Gwarancja 3 lat / 3 летняя / 3-річна гарантія
3 ani garanție / Guarantee 3 years

Made In P. R.C. 2016